

Computerized Selective Simultaneous Two Frequency Metal Detector

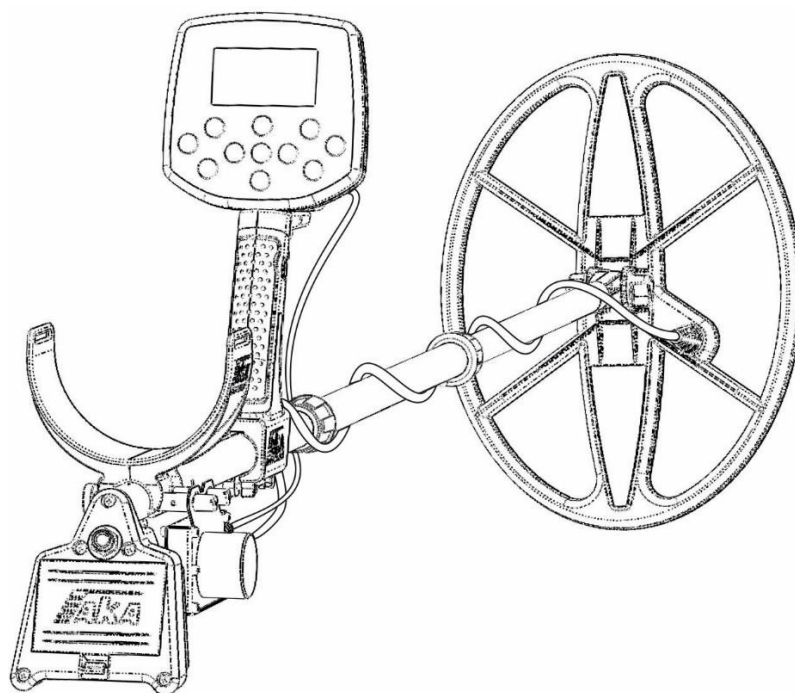

INTRONIK STF

Operation Manual Version 1.xx

Russia, Moscow, 2020

Departement of export

tel: +79030060666

Site: <https://aka-md.com/>

INDEX

Important Notice	3
General Description of the Device	3
Power Supply of the Metal Detector “Intronik STF”	3
Setting-up Procedures	4
Assembly Sequence	4
Control Elements and Connectors	7
Control Panel of the Metal Detector	8
Trigger	9
Display Data	10
Preparing Metal Detector for Hunting	11
Ground Compensation	12
Programs Requiring Ground Balance	14
Ground Evaluation Mode	16
Table Information for Ground Evaluation	17
«Quick Start». Factory Preset Programs with Ground Compensation Method	18
Factory Preset Programs	18
Settings	20
«M» (Main) Menu. Basic Hunting Settings.	21
«M1» Menu. Filters for Noise Signals and Error Signals.	22
«A» Menu. Audio menu. Basic Sound Settings.	24
«A1» Menu. Add-on Menu. Tone Settings, Settings for Tone Boundaries	26
«AM» Menu. Settings Menu for Discrimination and Identification	27
Enabling and Disabling of Discrimination Mode in 2F ID in Hunting Mode	27
«V» Menu. Video Menu. Display Settings, Settings for Data Display	29
«V1» Menu. Add-on Video Menu. Control of Data Display	30
Extended Explanation for Display Target Information	30
What is Hodograph	31
Simultaneous Analysis of Two Hodographs of Target Signal at High and Low Frequencies	32
Digital Data about the Target	35
Useful Links	38
Terms of Warranty	38
Terms of Interruption of Warranty Obligations	38
Warranty Certificate	39
Production and Sales Data	39

Important Notice

Manufacturer reserves the right to modify the design, configuration or manufacturing technology of the Product, in order to improve its properties, without any prior notice to the Buyer. The text and numbers in this manual may contain eventual misprints. In case if after having read the Manual you still have questions about the functioning and operation of the Device, you should contact your dealer or an authorized service center for further detailed information.

General Description of the Device.

“Intronik STF” is a Metal Detector designed to hunt and identify metal objects in dielectric media (dry sand, wood, etc.), as well as in weakly conductive media (soil, brick walls, etc.).

Scope of application of the Device:

- forensics;
- engineering troops;
- housing services, construction and fire extinguishing activities, in order to hunt for the underground utilities, pipelines, cables, manholes, etc.;
- archeology and treasure hunting.

Device is designed to operate under the following conditions:

- ambient temperature from -10°C up to + 40°C;
- relative humidity up to 98% under the temperature of 25°C;
- atmospheric pressure from 650 up to 800 mm Hg

Power Supply of Metal Detector “Intronik STF”

Metal Detector “Intronik STF” STF can be operated from a DC source with a voltage from 6,5 up to 12 V. Considering the design, there are two types of power supply:

either by using a cassette for 6 Ni-MH AA batteries (or 6 AA alkaline batteries), or power supply from two Li 18650 batteries.

Power consumption of the Device is approximately 250-260 mA.

It is recommended to use brand AA batteries with a capacity of at least 2600 mA.

In order to guarantee the operation of the Device for a full daylight period in summer (i.e. for more than 8 hours of hunting), it is recommended to provide the Device with 2 sets of fully charged batteries.

General Description of the Device

Assembly Sequence

1. Insert the top of the shaft into the middle section so that the metal clump on the top of the shaft could match the hole in the middle of the shaft, and then tighten the collet clockwise. It is not necessary to tighten the collet continuously; it is enough to turn it until a position to eliminate a gap between the middle and upper parts of the shaft. Otherwise, excessive rigidity of the collet tightening might cause its jamming, followed by its failure.

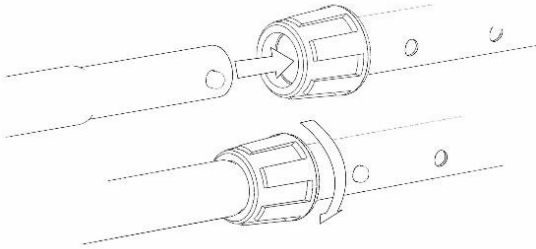

2. Insert the rod into the middle of the shaft and use the metal clamp on the stem and the holes on the middle of the shaft, in order to adjust to the desired length. Tighten the collet clockwise.

3. Attach the sensor to the rod of the shaft using the supplied plastic fastener (bolt + nut) and the rubber gaskets by perpendicular positioning of the sensor as related to the boom axis. In this case, the cable terminal from the sensor housing should be located to the right of the rod axis.

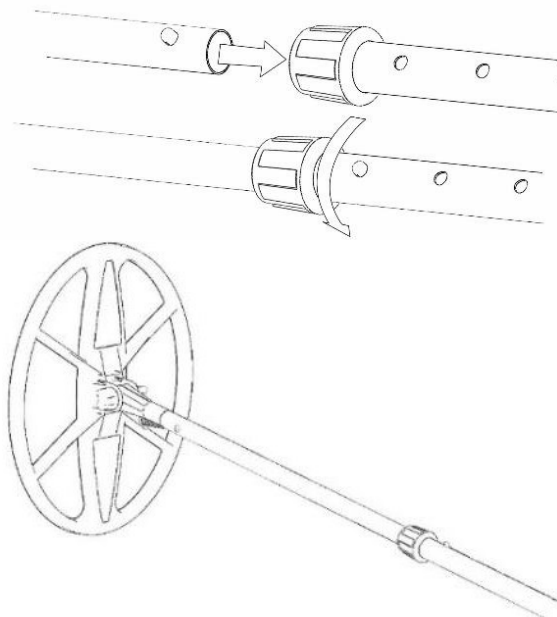

4. Wind the sensor cable so that the first coil would pass above the rod (see the figures). In case of any improper cable coil (located under the rod), the cable would be extremely bound when operating the Device with a probable gradual damage at the bending point.

5. Fix the sensor unit under the armrest of the Metal Detector with the special screw holders. Use a knife, a screwdriver or a hand, in order to tighten the mounting screws.

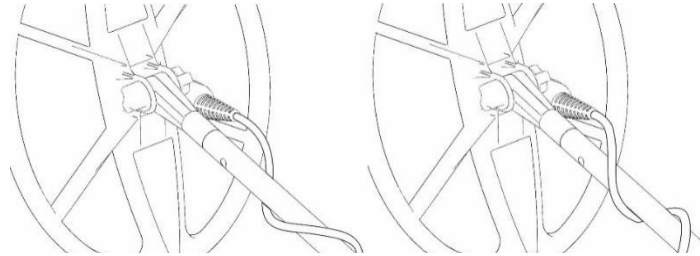

Не правильно

Правильно

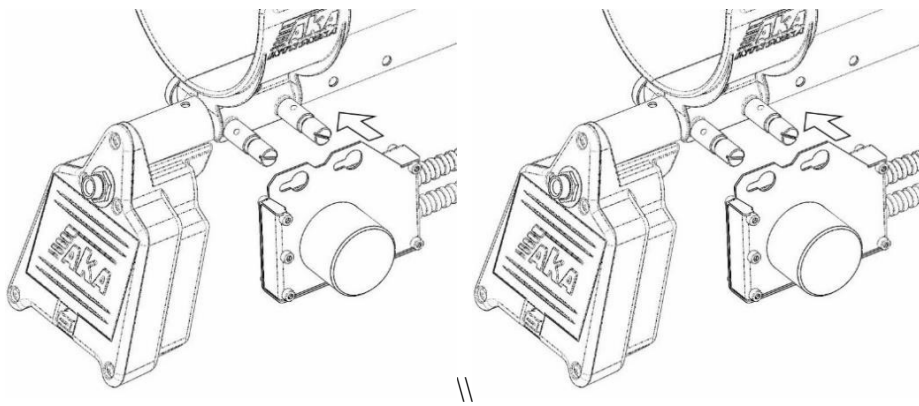

||

|

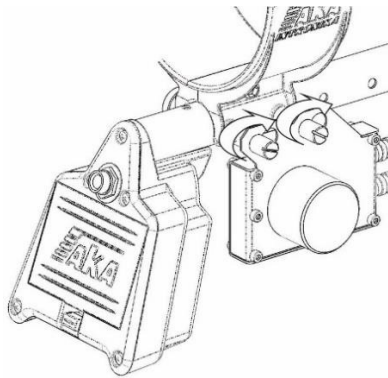

||

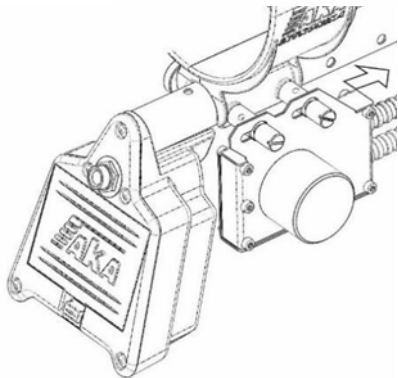

|

6. Attach the electronic unit of the Metal Detector to the mounting point upon the handle; fix it by sliding it forward along the mounting point until it clicks.

7. Connect the power cable to the slot upon the electronic unit, and tighten the connector nut.

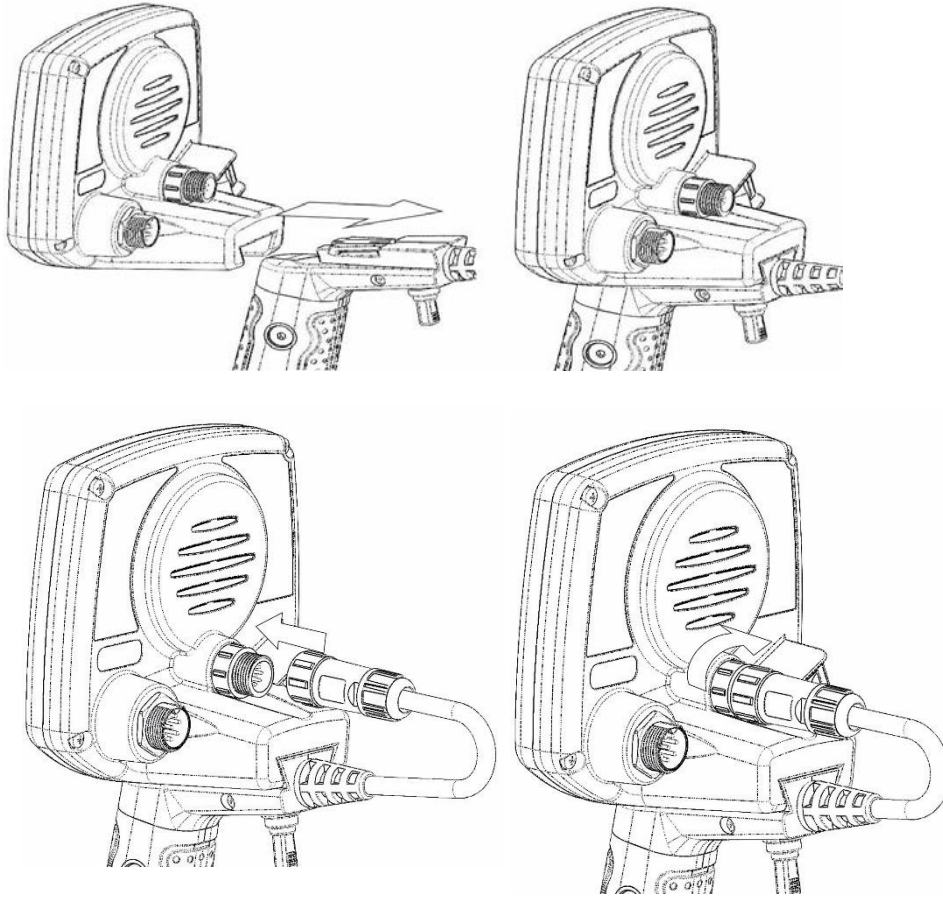

8. Connect the cable of the sensor unit to the connector on the electronics box, and tighten the connector nut. Assembly of the Metal Detector has been finished.

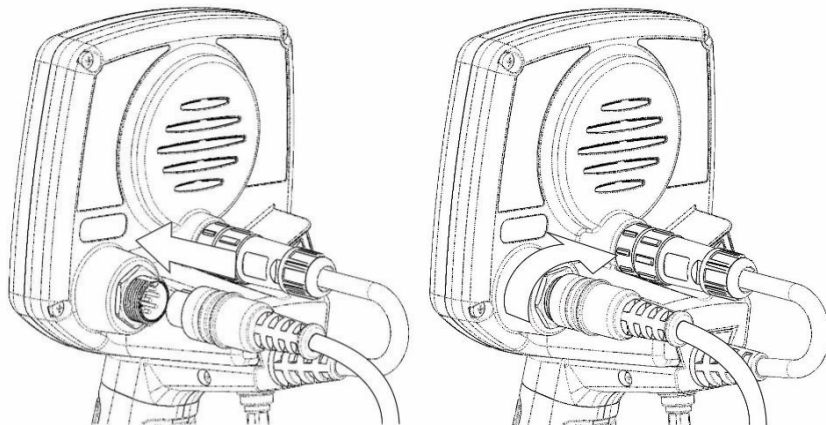

Control Elements and Connectors.



Control Elements and Connectors are located on the rear wall of the electronic unit of the Metal Detector (see the figures below), as follow:

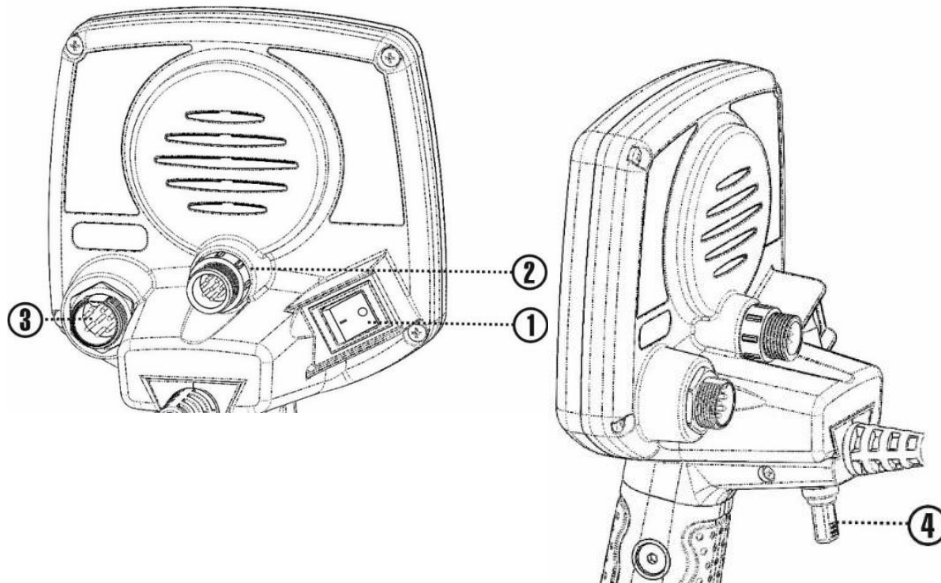





1. Button Off/Off of the Device
2. Slot to connect the power cable
3. Slot to connect the cable of the sensor unit
4. Trigger (switch) to provide quick access to the frequently used functions



Control Panel of the Metal Detector



1. Main Menu (short press), Filters Menu (press and hold).
2.  - Audio Settings. Main Settings (short press), Change of tones and tone boundaries  (press and hold).
3.  - Enabling and Disabling of Discrimination Mode in 2F ID in Hunting Mode (short press), Discrimination menu (press and hold).

4.  - Video Settings. Main Settings (short press), Enabling and Disabling of Data Display and Display Functions (press and hold).
5.  и  - Changing the level of settings in the Metal Detector Menu.
In Hunting Mode – press button “+” to increase, and press button “-“ to decrease **Speed** (see the Section “Settings”). In manual mode of within Ground Compensation and Ground Balance, adjustment of the accuracy of the setting preformed.
6.  - Scroll between the Menu Items. In Ground Compensation Mode to amplify the signal vector from the ground. In the Ground Balance mode for the Program №7 “Increased sensitivity 2S” for switching between frequency vectors in manual settings.
7.  - Scroll between the Menu Items. In Ground Compensation Mode to attenuate the signal vector from the ground. In the Ground Balance mode for the Program №7 “Increased sensitivity 2S” for switching between frequency vectors in manual settings.
8. Exit from all the Settings and Ground Compensation Mode into the Hunting Mode. In Ground Compensation Mode to enable/disable the Pinpoint Function (detailed target location).
9.  - Enter Ground Compensation Mode. Enter Ground Balance Mode or the Programs that require Ground Balance (short press). Enter “Ground Evaluation Mode” (press and hold).
10.  - Enter Program Switch Mode. Switching the Programs in sequence by short pressing of the same button, or the “+” button. Scrolling back with the “-“ button.

Trigger.

Trigger is a switch designed for 3 positions without any fixation, i.e. when pressing the switch forward or backward with its further release, the lever would not retain its position appointed by pressing, however it will return to its middle position.

Trigger is designed to provide quick access to the frequently used functions when operating the Device, in particular:

1. Press forward and hold, in order to enter the Ground Compensation Mode (in Programs № 1, № 2, № 3, № 4, № 6) or Ground Balance Mode (in Programs № 5, № 7), similar to the related button. Having entered the Mode, release the trigger.

After performing Ground Compensation or Ground Balance, pull the trigger shortly, in order to return to the Hunting Mode.

2. Press and pull, in order to enter the Pinpoint Mode while staying in Hunting Mode. The mode is active as long as the trigger is being pressed. Release the trigger, in order to return to the Hunting Mode.
3. Short press and pull, in order to exit from all the Menus and Modes, Ground Compensation and Ground Balance Modes (similar to the related button) back to the Hunting Mode.

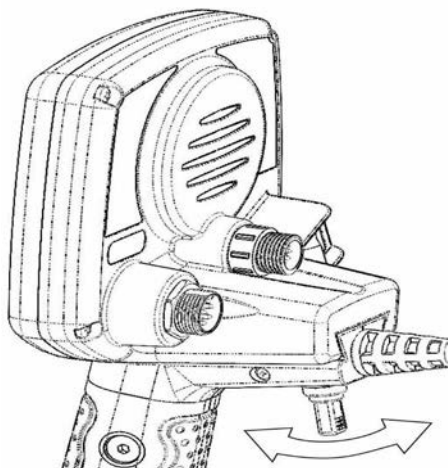

Display Data

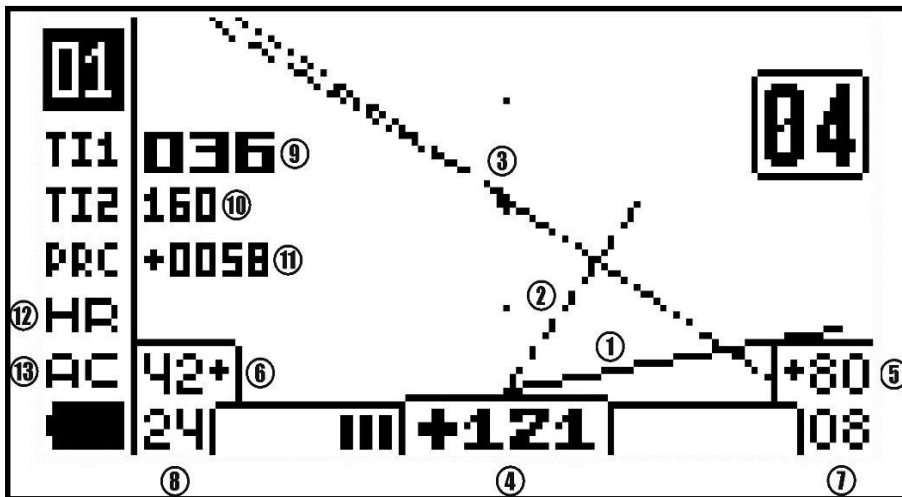

Hodographs

1. SFT High Frequency Hodograph (HF)* becomes displayed after the target identification, being saved on display until the next target is identified.
2. SFT Low Frequency Hodograph (LF)* becomes displayed after the target identification, being saved on display until the next target is identified.
3. D Hodograph (2F)* gets displayed in real time while the coil passes over the target, being deleted from display after the target leaves the coil range or the coil stops moving.

Digital Data related to the Target

4. 2F ID * (000...180) means a Dual Frequency ID (identification number) of the target. It corresponds to the angle of deviation D of the hodograph of the target signal from the vertical axis. Depending on the identification of the target by the Metal Detector, it displays either a minus (iron targets) or plus (non-ferrous targets) value.
5. VDI (HF) * (-99...0 ...+ 99) means Single-frequency target VDI at high frequency.
6. VDI (LF) * (-99...0 ...+ 99) means Single-frequency target VDI at low frequency.
7. Signal rating (HF) * (00...99) means Signal strength of the target at high frequency. Scale and numerical value.
8. Signal rating (LF) * (00...99) means Signal strength of the target at low frequency. Scale and numerical value.
9. Ti1 (Target index) * (000 ... 999) means a Dual Frequency Target Index. It provides information about the aggregated value and conductivity of the target.

10. Ti2 (Target Index 2) * (000...999) means Additional Dual Frequency Target Index. When compared with the basic Ti1, along with related experience, it can provide the specified information about the target character.

11. PRC (Probability Coefficient) * (0000...9999) means "Probability coefficient" of the target. It provides separating clear metallic targets from non-metallic signals when required.

12. HR (Hot Rocks): this symbol appears when the BG Filter is enabled. It provides the signal about its operation.

13. AC (Anti Caps): this symbol appears when the Fe Caps Filter is activated, it displays its operation.

* See Section "Extended Explanation for Display Target Information" for more detailed description.

Preparing Metal Detector for Hunting. Coil Adaptation (Sensor Adaptation).

When switching on the Metal Detector for the first time, as well as when changing the sensor (coil) and after re-setting it up to the factory settings, you need to adapt the sensor to the Metal Detector. For this operation you will need a ferrite rod, it is normally supplied with the Device (any other ferrite sample, either). Connect the required sensor to the Device and place (or hold) the Device away from metal structures and ground (there may be undetected metal in the ground), switch it on while pressing down the button. 

Wait for the digital values of the sensor operating frequencies to appear on display:

Release the button and wait for the adaptation display to appear: 



Slowly bring the ferrite rod with its tip to the center of the sensor at a distance of 50-60 cm and at a distance of 30-35 cm. Do not bring the supplied ferrite rod too close to the sensor. In this case, along with each presentation of the ferrite rod, the vectors will be displayed and the horizontal high and low frequency scales will begin to fill in the space on both sides.

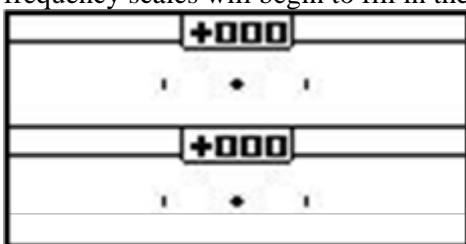

Repeat for 3-4 times. When the processor of the Metal Detector has accumulated the required number of repetitions, the scales will fill in completely, the vectors will take a horizontal position, the audio signal of the adaptation progress will beep (two short beeps in a sequence), thus, the adaptation of the sensor has been completed.

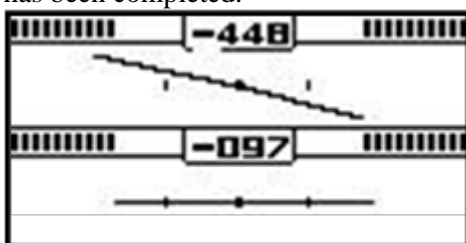



Press the button  in order to exit into the Hunting Mode.

Next time, the adaptation of the sensor will only be required in case of its replacement for another one, after resetting to the factory settings, or after the related software update.

(!) REMEMBER that before starting the hunting, the Ground Compensation will be required to be performed directly at the hunting site.

Ground Compensation.

Before the operation gets started, the Ground Compensation will be required to be performed directly at the hunting site.

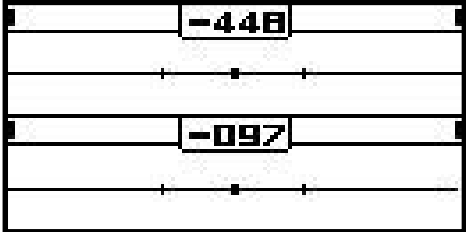
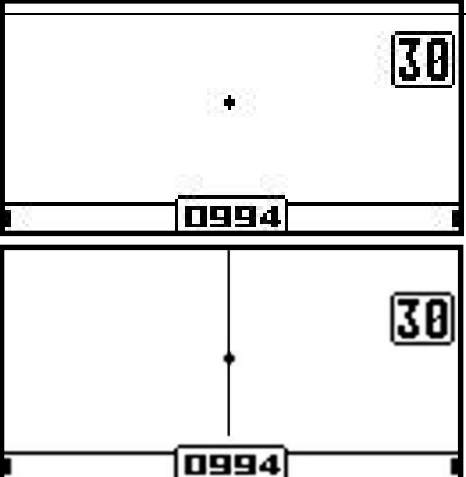
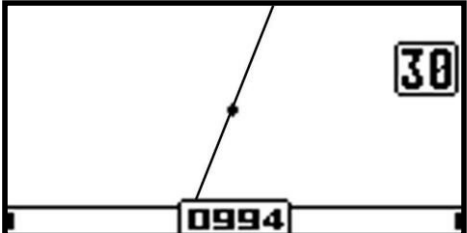
<p>(!!!) Operation of the Ground Compensation should be performed and saved separately for each hunting program!</p> <p>For this purpose, switch the Device on, then, moving the sensor over the ground smoothly, find a plot free from metal pieces.</p>	
<p>!) In a place free from metal pieces, with a smooth movement of the sensor, there will be no sharp increase and decrease of the detection signal, even in a Device with uncompleted Compensation.</p> <p>Once you have found a clear plot, switch to the Auto Compensation Mode by pressing the trigger forward and holding it. Having entered the Mode, release the trigger (you can also enter the Compensation Mode by shortly pressing the button on the Device Panel).</p>	
<p>Swing the coil vertically above the ground, raising it at a distance of 15-20 centimeters, and then lowering it at 3-4 centimeters above the ground. (Do not lower the coil when performing Ground Compensation close to the ground!). You will detect the signal vector, coming from the ground, and you will hear a zoom, at the moment when the sensor approaches or moves away from the ground. Simultaneously, two horizontal scales will start filling in the bottom of the display. Make the repeated vertical moves with the coil, until the scales have been completely filled in, and the vector will automatically take a strict vertical position, and the zoom from the ground will disappear, either, or (on mineralized grounds) it will become as quiet as possible, thus the “beating” will be heard when lowering and raising the coil. In case if the vector has not taken a strict vertical position the first time, continue moving the coil over the ground. The scales will be filled in again; the vector will take its vertical position.</p>	

Here is an example of an incorrect vector position, when the compensation should be repeated:

(!) In case if the line of the ground vector is uneven and looks like a loop-shaped path, it means that you have chosen too strong amplification for this specific ground (or there is external electromagnetic interference as well).

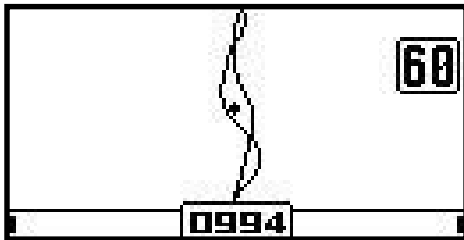

You should exit the Compensation Mode by pulling the trigger (or by pressing the button ) , make the amplification lower and repeat the compensation procedure.



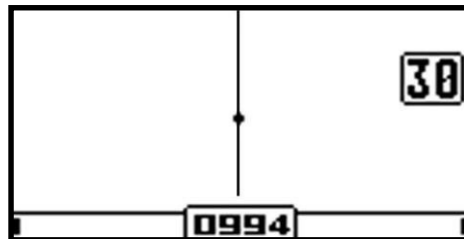

Incorrect



Correct

When hunting for deeply located targets at high sensitivity level, or upon complicated signal ground, then automatic compensation may not be accurate enough. In order to achieve the most accurate ground compensation alignment within the ground compensation, you can switch to manual mode by pressing either the button  or the button .

Besides, you can adjust the ground vector with the same buttons to the right  or to the left. 

(!) A sign of fine tuning will be resented by a minimum presence of a sound, along with vertical movements of the coil of the Device above the ground.

While operating on dry and less conductive grounds, you may find that the ground vector might be almost invisible on display; besides, it can be too small to perform automatic compensation, either.

Using the button  you can amplify it up to the required size (approximately the edge of display), having amplified the signal of the ground conductivity for the Metal Detector, use the button to decrease. To the right of the vector, the amplification number is displayed. Thus, you will be able to make compensation for less conductive or less signaling ground.

(!) Avoid to keeping the increase in the conductivity signal (vector) of the ground for more than x 10 times, if no required. This can affect identification on highly conductive grounds. That is, if after the place where you had to increase the ground vector, you find yourself upon a plot with more conductive ground, use the button , in order to decrease the ground vector to the minimum (display border), or up to 00 magnification value, if the vector still remains larger than the display border.

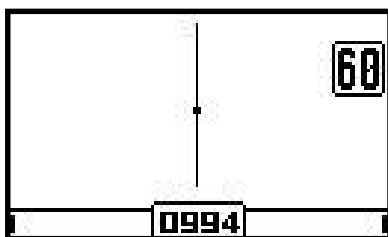

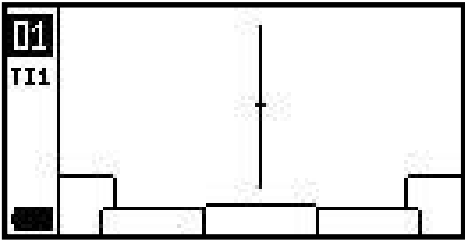
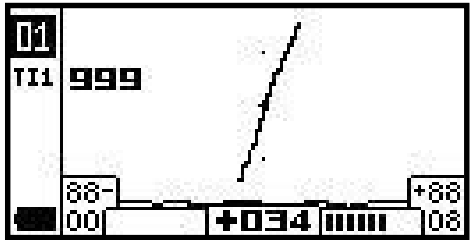
<p>(!!!) It is easy to check the accuracy of the ground signal compensation immediately during the hunting. In order to do this, find a plot free from metal pieces, swing the sensor up and down over the ground.</p> <p>In case if you can see a vertical line on the display of the Metal Detector, however, you will not hear the sound of the Detection Channel (besides, no sound of the Identification channel will be identified!), it means that the ground compensation is correct and does not require any adjustment.</p>	
<p>In case if the vector gets deviated from the vertical axis, and the sensor approaches and moves away from the ground, you will hear a clear signal from the Detection Channel, and, moreover, the signal of the Identification Channel, it means that the ground signal compensation is not correct, you need to repeat the procedure.</p>	

Programs Requiring Ground Balance

Some special additional programs of the Metal Detector “Intronik STF” require a Ground Balance procedure. Program № 5 “DL Deep Hunting” requires first to perform Low Frequency Ground Balance, then the Ground Compensation. Entering the Ground Balance mode is performed in the same way as per the Ground Compensation Mode, by pressing the button  or holding the trigger, pulling it away (after entering the mode, it’s necessary to release the trigger).

Select a clean patch of soil. With Ground Balance turned on, swing the coil vertically above the ground, raising it 15-20 centimeters, and lowering it to a height of 3-4 centimeters above the ground. (Do not lower the coil when performing Ground Balance and Ground Compensation close to the ground!)

The scales at the top of the display will be filled up with a beep afterwards, and the ground signal vector will be automatically put in horizontal position.

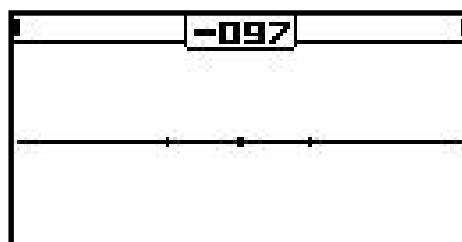
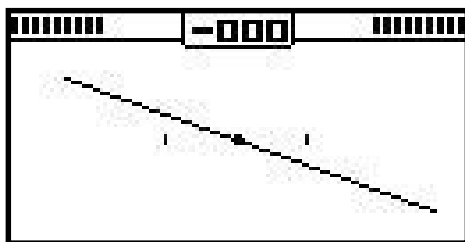

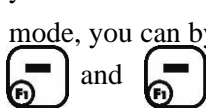

At the same time, the zoon from the movement of the coil over the ground will calm down. If you are not satisfied with the accuracy level of horizontal position, being performed in automatic mode, you can by pressing the button  again, switch to the manual mode, and using the buttons



buttons and adjust the vector’s position.

Having completed the Ground Balance procedure, exit this Mode by pressing the button  (or by shortly pulling the trigger). The Detector will be switched into the Ground Compensation Mode.

Follow the procedure, as described in the Section “**Ground Compensation**”. Having completed the procedure, enter the Hunting Mode by pressing the button  or by shortly pulling the trigger.

Program № 7 “Increased Sensitivity 2S” requires only Ground Balance Procedure to be performed at both operating frequencies. You can enter the Ground Balance Mode in the same way as you enter the Ground Compensation Mode, either by pressing the button  or by holding the trigger and pulling it away. (Having entered the Mode, release the trigger).

Pump the coil vertically over the ground, raising it at a distance of 15-20 cm, and then lowering it at 3-4 cm above the ground. (Do not lower the coil when performing Ground Compensation close to the ground!).

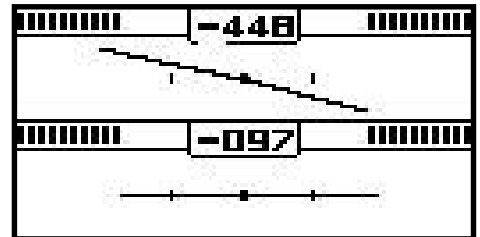



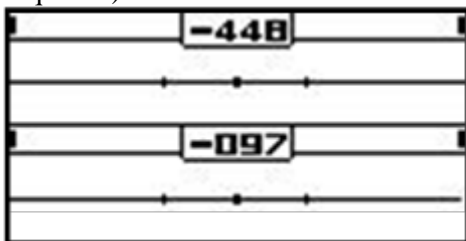

You will hear the zoom of the “unturned” ground, besides, you will see the bars to be filled in above high and low frequency vectors. Repeat it for 3-4 times. When the processor of the Metal Detector has recorded the required number of repetitions, the bars will fill in completely, the vectors will take their horizontal position, the audio signal of the adaptation progress will emitted (two short beeps in a sequence).



The absence of any zoom, when pumping and lowering the sensor, as well as the strict horizontal position of the ground vectors at both frequencies, will confirm the correct way to have performed the Ground Balance procedure.

If you can't achieve maximum accuracy in automatic mode, you can adjust the vectors' position in manual Ground Balance Mode. In order to do this, press the button  again.

The Device will be switched off, while you manage to adjust the vector of the corresponding frequency in a horizontal way as accurately as possible with the buttons  and , in order to achieve the minimum level of zoom from the ground, along with the vertical movement of the Metal Detector's coil.

You can switch between the frequency vectors, using the buttons.  and .

Having completed the Ground Balance procedure, press the button  or shortly pull the trigger, in order to enter the Hunting Mode. You can start hunting now.

(!) Ground may change considerably In the course of your moving. Metal Detector can start emitting “phantom” signals, being operated upon uneven grounds, first with the Detection Signal, and in case of any considerable change it can emit the Identification Signal. In this case you should adjust the Ground Balance by means of repeating the adjustment procedure over again.

Ground Evaluation Program.

Main parameters of the ground that affect the operation of the Metal Detector are its magnetic and conductive characteristics. Depth and identification directly depend on those parameters.

Magnetic mineralization significantly reduces the detection depth for the targets, when using the single-frequency Metal Detectors. Due to the Ground Compensation Method to be applied, the Device "Intronik STF" is much less affected by this parameter, as far as the detection depth is concerned.

In a certain point of time, the increasing ground conductivity deprives the single-frequency metal detectors of their operative properties, as they start to generate too many "phantom" signals upon the ground; thus, they make it impossible for their operators to hunt upon such ground plots. Examples of such grounds are such territories as wet swampy river floodplains, shorelines of salt lakes, along the sea line as well. Multi-frequency Metal Detector, the Device "Intronik STF" perfectly deals with the growth of ground conductivity and in main hunting programs of the Ground Compensation (№ 1, № 2, № 3, № 4, № 6); it provides the efficient hunting in the environment where the single-frequency metal detectors become non-operational.

However, hunting procedure, when using the Device "Intronik STF", is affected with the magnetic properties and conductivity of the ground. Though this effect is much lower, compared to the operation with the single-frequency detectors, we should still consider its impact, in order to provide the maximum efficiency of the Device. It's necessary to get informed about the values of such ground characteristics at the hunting area.

You can operate using the special "Ground Evaluation Program".

You can enter the Program by holding the sensor of the Device at hip level above the ground, pressing and holding the button  until the starting-up display picture appears for the Program.

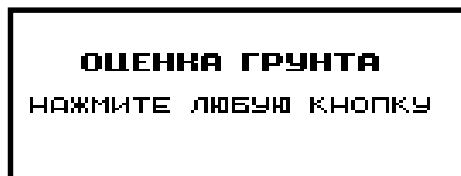

Then press any button to start the Ground Evaluation procedure, the dual frequency display for the Ground Balance will appear:

Lower the sensor towards the ground at a height of 3-4 cm above the ground, at hip level, do it with quick but smooth movements (without pulling), and lift it back up to the hip level. Repeat the procedure for about 3 times, until the ground signal bars have been fulfilled and the beeps that signal the evaluation completes, thus, the table will be displayed.

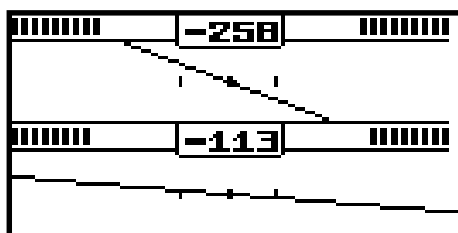
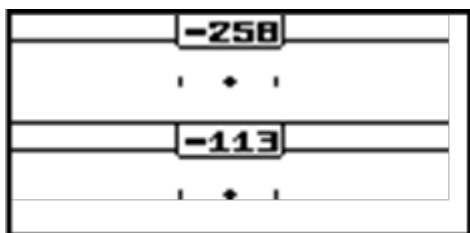

Table Information for Ground Evaluation

Amplitude (000...999) means signal intensity of a magnetic component of the ground. When hunting with the Metal Detector “Intronik STF”, it mainly affects the identification of the targets by classifying the as non-ferrous or ferrous ones; i.e. it affects such values as “plus” or “minus” within 2F ID range, while it provides little effect upon the detection depth and a digital within 2F ID range.

АМПУИТУДА	003
ПРОВОДИМОСТЬ ...	+17.3
ВЧ	22.7
НЧ	05.4

Range 000-002 means very light-textured ground. You can totally trust the identification properties of the Metal Detector.

Range 003-006 means low-mineralized ground. However, deeply located non-ferrous targets are already often referred to the ferrous ones, due to the classification of the ground signal, especially when the coil is quickly run. At the beginning such operation upon such grounds, it is recommended to gain practical experience, by extracting not only obvious “non-ferrous” signals, but also suspicious “ferrous” signals. You should perform repeated checks of the targets by smooth and slow operation of the coil.

Range 007-010 means a medium-mineralized ground. Identification of the deep targets in such grounds requires a high level of skills in Detector’s, as well the practical experience. Recommendations are the same as for the grounds to be operated with 003-006 range, yet you should take into account rather a greater number of “non-ferrous” targets to be referred to the “ferrous” targets due to an intense ground signal.

Range 010-020 means highly-mineralized ground. Identification of the deep targets with the Device looks rather relative.

Range 030-060 and over means very mineralized ground. Using the Device “Intronik STF” you can detect many “ferrous” targets which would not be accessible mainly by the ordinary detectors, except for the pulse devices. However, the identification of superficial targets will require a lot of experience working upon such grounds, it is often operated at level of intuition.

Conductivity (00.0...99.9) means the conductivity level of the ground. It also affects the identification by adding the ground conductivity signal to the target signal, yet its impact is much lower than the magnetic influence. It modifies the 2F ID range of the deep targets up to 000 or 180, which will not be detected by the sound emitted by the Device.

Range 0.0-..+05.0 means low conductive ground. Practically, it provides no impact upon the depth and identification of the targets. The option of the efficient operation is provided not only in basic hunting programs, but also in those programs that require ground balance procedure on one or both frequencies, i.e. such programs as DL Deep Search Program (№ 5) and High Sensitivity 2S Program (№ 7).

Range +10.0 - +20.0 means medium-conductive ground. It provides little impact upon the depth and modifies the 2F ID range of deeply located targets up to the limit values of the bars (001... 005 - 170... 175). Operating in programs that use the Ground Balance procedure can be problematic, due to the excessive number of phantom signals. Probably, their operation upon such grounds, using low-frequency sensors of “214” series, as well as with the sensors of “540” series is not recommended, due to the application of the programs with the Ground Balance procedure Ground Balance.

Range +25.0 - +35.0 means highly-conductive ground. It provides little impact upon the depth, however it modifies the 2F ID range of the targets up to the limit values of the bars (001...005 – 170...175). It’s not recommended to operate in programs that use the Ground Balance procedure. It’s recommended to use the programs based on Ground Compensation Method, in order to perform the superficial ground hunting (№ 1, № 2, № 3, № 4, № 6). It is not recommended to set the gain value of the ground conductivity signal (vector) for more than 00 in the GC. If the vector displays double or loop values in CG, you should reduce the Gain value in the “M” Menu of the Metal Detector.

Range +40.0 and over means extremely high-conductive ground. It’s recommended to use the programs based only on Ground Compensation Method, in order to perform the superficial ground hunting (№ 1, № 2, № 3, № 4). It’s not recommended to set the Gain value of the ground conductivity signal (vector) in GC for more than “00” value. If the vector displays double or loop values in CG, you should reduce the Gain value in the “M” Menu of the Metal Detector.

HF (high frequency) means the difference between ground phase and ferrite phase at high frequency

LF (low frequency) means the difference between ground phase and ferrite phase at low frequency

«Quick Start». Factory Preset Programs with Ground Compensation Method

Programs of Ground Compensation Method are the basic Hunting Programs provided for the Metal Detectors “Intronik STF”. They can be operated upon majority of low- and highly-mineralized grounds, as well as on conductive (“salty”) grounds.

Switch the Device on and perform the procedure of Sensor Adaptation*.

Chose the most appropriate hunting program from the list:

Program № 1 “Initial Mastering”. It’s the most “friendly” and easy-to-find program for the initial mastering of the Metal Detector, if you perform your first hunting session with the Device “Intronik STF”, or if you are not experienced enough to adjust the Device by yourself for more sensitive programs, in order to operate in difficult ground environment. This Program is operated in accordance with the Ground Compensation Method.

Program № 2 “Standard Hunting”. It’s the most balanced program in terms of depth and speed of detection for most hunting options, being designed for an operator who has already mastered the Device “Intronik STF”. This Program is operated in accordance with the Ground Compensation Method.

Program № 3 “Deep Hunting”. Program is designed to hunt for deep targets located on ground areas that contain a small amount of metal debris. Program provides the increased detection depth and low speed. This Program is operated in accordance with the Ground Compensation Method.

Program № 4 «Quick Hunting». If the hunting area contains enormous amount of metal debris, the Program provides high speed and slightly reduces the depth. This Program is operated in accordance with the Ground Compensation Method.

Perform the Ground Compensation** procedure, using the chosen program.

Get you hunting started, we wish you good luck!

* See Section “Sensor Adaptation (Colil Adaptation)”

** See Section “Ground Adaptation”

Additional Factory Preset Programs for Hunting

Program № 5 “Deep Hunting DL”. It’s recommended to use this Program, in order to hunt for mainly large and highly conductive targets. It has equal sensitivity to small and medium-sized targets in relation to the basic Ground Compensation programs; however, at the same time it possesses the increased level of sensitivity for large and highly conductive targets.

If required, and taking into consideration the hunting aimed only at large targets, in this Program the sensitivity to small targets can be reduced by adjusting such setting as “Sensitivity for Small Targets”. In contrast to the Basic Hunting Programs, it is operated simultaneously by both Ground Compensation Method and the Ground Balance Method (at low frequency). This Program is capable of being operated upon low- conductive and medium- conductive (“salty”) grounds.

(!!!) Program is not recommended for operation upon highly-conductive grounds.

Program № 6 “Deep Program GP”. This unique Program allows the Metal Detector “Intronik STF” to be operated as a device designed for deep hunting. In particular, their operation is similar to the models of the split and deep hunting devices, such as “Whites TM808” and “Pulse Star”. Program is designed to hunt for large items located deeply in the ground, as well as in the debris environment containing small metal items that reflect the signal of the targets to be hunted during the standard procedure. Hunting is performed with smooth horizontal moves of the sensor (speed is approx. 4 seconds per one run in one direction). The speed of the sensor’s run can be slightly reduced or increased depending on the situation. Sensor is wired at a height of 5 cm up to 1 m, depending on the density/size of the superficial metal debris over the locations of the targets to be hunted.

The ordinary scanning height is 40 -70 cm, when operating upon the grounds in the sites of late civil settlements, where a large number of nails and other small metal debris are found, as the experienced operators say.

Identification of a large item is specified by a large “site” of the ongoing detection signal. Identification by hodographs is similar to any other hunting modes. Identification sound type of “non-ferrous” and “ferrous” targets depends on the mode “Signal Type” to be selected in “A” Menu:

1. 1 Tone Signal for all types of targets, the same tone for all the items.
2. Multi - Tone Signal: low tone for “ferrous” targets, one of 4 high tones for “non-ferrous” targets.
3. 99 Tones: polyphonic sound mode for target identification; low tone for “ferrous” targets, polyphonic multi-tone signal for “non-ferrous” targets.

(!) In order to master the Program and the related sound options for small and large targets, as well as for the large targets to be distinguished with little iron debris, it’s strongly recommended to perform a training session in a testing pit with the proper targets before the operation. For example, you can make the imitation of a monetary treasure to be positioned under the nails, or some helmets (in order to train the military scouts).

(!) Deep Program GP of the Metal Detector “Intronik STF” can also be used as a program for the regular ground hunting. However, you should remember that the accuracy of identifying the deeply located targets within this Program is somewhat inferior to the characteristics of the Programs № 1, № 2, № 3 and № 5, in particular, while operating upon the grounds with increased magnetic mineralization.

Program № 7 «Increased Sensitivity 2S”.

Program provides the highest sensitivity as related to small and weakly-conductive targets. It also provides a little bit higher sensitivity as related to middle-sized-, large- and highly- conductive targets within light-textured grounds, as compared to the basic hunting programs that use the Ground Compensation Method. This Program is operated in accordance with the Ground Balance Method. Program is recommended mainly, in order to hunt for small and low-conductive targets upon dry and non-conductive grounds. **Program is not suitable for working on conductive (“salty”) grounds!**

You can operate it upon damp and weakly conductive grounds with the reduced sensitivity settings. In order to hunt for large and highly conductive targets located at maximum depths (only upon non-conductive grounds), it’s recommended to reduce the factory preset value of the “GB Filter” (Ground Balance Filter) to the minimum comfortable value.

(!) A simple rule: if your Metal Detector at the hunting ares operates too noisy (i.e. it emits a great number of false signals upon the ground) in such Programs as “Deep Hunting DL” or “Increased Sensitivity 2S”, you should use the Ground Compensation Programs, in order to operate upon the majority of the mineralized grounds, in particular: use the Programs № 1, № 2, № 3, № 4 and № 6.

Settings

Settings of the Device are arranged in groups according to the corresponding menu items



1. «M» Menu. Short press. Hunting Settings.
2. «M1» Menu. Long press. Setting for Hunting Filters.
3. «A» Menu. Short press. Basic Sound Settings.
4. «A1» Menu. Long press. Settings for Tone Boundaries.
5. «V» Menu. Short press. Basic Video Display Settings.
6. «V1» Menu. Long press. Add-on Video Display Settings.
7. «AM» Menu. Long press. Settings Menu for Discrimination and Identifications

*** those are the settings marked with three asterisk, they are present only in certain special programs, which are indicated in the setting description.

«M» (Main) Menu. Basic Hunting Settings .

Press the button  to enter.

Gain (01...27) means the overall sensitivity of the Device. Due to increasing or decreasing of the value you can adjust the target detection range of the Metal Detector. Having modified the gain, you should perform the Ground Compensation procedure.



(!) You should remember that this setting affects the gain of all the signals: target signals, ground signals and interference signals. Gain value should be adjusted based on the hunting environment: ground mineralization, density of vegetation, external electromagnetic interference. If you select an extremely high value, your detector can operate in a too noisy way, thus, you will miss the identification of deeply located targets.

(!) Gain scale has 27 items. It allows to compensate for the loss of sensitivity, when the value of Speed setting is high or when the Operating Frequency has been shifted. For example, at the Highest Speed the setting is “8”, the gain value equal to “27” is the operating level in suitable environment. However, low values of the Speed setting equal to “1,2” and, moreover, under its negative values, the maximum operating Gain value will be significantly lower.

Speed (-02 ... 00 ... 08). This setting allows you to adjust the ability to detect the second and subsequent targets after the sensor of the Device has passed over the target. The higher is the value, the shorter is the distance and the faster is the speed for your Metal Detector to separate one target from another. However, you should remember that the higher is the speed, the less is the depth of your Device. In case if this characteristic is not preferable, you can increase the Gain value up to the comfortable level, with the required sensitivity level of your Metal Detector.

(!!!) When hunting for the deeply located targets upon the area which are free of debris, first of all it's recommended to reach the depth by reducing the Speed up to the value not higher than “02”, and only then you can operate with the increased or decreased Gain values until you achieve the comfortable level.

(!) “Negative” speed values, such as “-2” and “-1”, are distinguished by the maximum available depth of target detection, but are applied only when hunting for the loose targets, which are located upon non-mineralized grounds and plots that are free of metal debris (except for the special Deep Hunting Program - DH).

(!) While hunting, you can quickly adjust the Speed value by using the following buttons for increasing  and decreasing .

Sensitivity for small targets (01 ... 22) (this option is set within DL Program only). This setting significantly reduces the sensitivity of the Device for the small targets. Its sensitivity for the large targets is reduced as well, yet to a lesser extent. This option can be applied when hunting for deeply located large coins, upon the plots that contain a large amount of small rusty fragments of decayed iron.

Sensitivity of Identification (00... 20) means the sensitivity of the identification channel. The higher is this setting value, the weaker (deeper, weaker) signals will be emitted by your Device through one of its identification tones. Identification operates by the post-evaluation mode. Therefore, its audio signal is emitted after the Device has evaluated all the parameters of the target, and the coil of the Device has passed over the target. Target identification signal is switched off under the setting level equal to “00”.

(!) Excessive reduction of this setting makes your Device less noisy; however, you are sure to miss both deep weak signals, as well skip the superficial and very small targets. Besides, it may also interfere negatively with distinguishing the targets within debris environment. Therefore, first of all it's recommended to adjust the depth and noise options of your Metal Detector, by means of decreasing the Gain values, yet without reducing the value of the identification sensitivity below “13”, unless necessary, when hunting for small targets or operating upon the grounds which contain much iron debris.

Sensitivity of Identification means the sensitivity of the identification channel. The higher is this setting value, the deeper targets your Device can detect, and emit a related audio signal from the detection channel. Detection channel operates in real time mode. It marks with the audio the presence of a target from the moment of its detection until the moment when its signal disappears. Value of its highest volume refers to the center of the detected target. Target identification signal is switched off under the setting level equal to “00”.

(!) It's recommended to keep the sensitivity of the detection channel at least equal to or slightly higher than the sensitivity of the identification channel. It will provide the deeper registration of the presence of targets in the ground, including the targets with deeper locations because the Device may probably miss them, due to its detection properties.



(!) In case of operating upon the grounds which contain huge amount of debris, especially the large-sized ones, you can reduce the maximum volume of the detection channel audio signal in the “A” Menu by adjusting the “Maximum Detection Volume”.

Threshold Tone Volume (OFF...0...20). It is constant background audio signal emitted by the Metal Detector. It helps you focus on weak and deep signals. This setting is applied, in order to switch it on and adjust the volume. Threshold Tone is switched off under “OFF” setting volume. You can adjust the value of the Threshold Tone in the “A” Menu Sound Menu with the “Detection Tone Frequency” option (the sound frequency of the Detection and Threshold tones is equal).

(!) We recommend to apply this function when operating with the headphones, and keeping the Threshold Tone a little louder over the audibility edge. Too loud Threshold Tone will result in rapid fatigue due to the sound overload, as well it may cause skipping the weak and quiet signals.

“M1” Menu. Filters for Noise Signals and Error Signals.

To Login use long pressing of the button 

Frequency Offset (-05... 0... + 05). This setting is designed to offset the operating frequency of the Device. Offset may be required if another Detector is operating nearby at a similar frequency. It can also be helpful, if there is any other EMI generator, being located nearby and working at the similar operating frequency of your Metal Detector. Offset is performed by pressing the buttons  or .

It is obligatory to perform the Ground Compensation procedure after having completed the offset of the operating frequency over again.

(!) If you are working upon a small area next to the plot, where another Metal Detector “Intronik STF” is operating at the same pair frequency, it’s recommended to tune the Devices separately from each other, and offset the operating frequency for both Devices in the opposite direction. In case if three Devices operate upon the plot, you can adjust one of them at the Offset Frequency to “00” value, and offset the frequencies for the other two in different directions.

(!) When the frequency has been offset to its extreme position, the Metal Detector is deprived of approx. 3% of its sensitivity. This lack can be compensated by increasing the Gain value by one or two points.

EMI filter (OFF...01...30) means the electromagnetic interference filter. It is designed to reduce the generation of false signals by the Metal Detector when hunting next to the sources of electromagnetic interference, among which there are such utilities as the power lines, transformer substations, gas pipelines, etc. Increasing its value reduces the effect of such interference; however, it slows down the operation of the Metal Detector. You should reduce the speed of the coil’s run over the ground, if the filter EMI values increase, in order to compensate for this negative effect.

(!) When the filter value is over “08”, it affects negatively the distinguishing of the closely located targets. Try not to increase its level over this value (08), when operating upon the grounds, where the density of targets, including the debris, is more than two items per one complete run of the coil, unless necessary.

(!) You should use the EMI filter in complex with the Noise Suppression for the most efficient interference suppression, along with the least impact upon the operation of your Metal Detector. It’s better to increase the small value for each of them, than to increase one of them up to a high value.

Noise Suppression (-04...00...24). This filter is designed to reduce the noise of your Metal Detector when operating in noisy environments, upon mineralized grounds and hunting in dense vegetation areas. Keep this filter at the lowest possible value, if your targets are very small, increase the value only if the noise of your Metal Detector in those specific hunting environment interferes with the target detection in the course of hunting.

(!) Deterioration in the sensitivity of the Metal Detector to distinguish the small targets, along with the increasing level of this setting can be compensated in a certain way by means of decreasing speed of a coil running over the ground.

(!) Target Detection Depth of your Metal Detector is also slightly reduced under the maximum values of the Noise Suppression.

PRC Filter (OFF...0050...9999). It’s a filter operated in accordance with Probability Coefficient (PC). It is designed for “cutting-off” the target signals of “non-ferrous” nature, mineralization gradient, shocks, stones, electromagnetic interference, etc. Distinguished superficial audio signals from metallic targets are usually characterized by a coefficient close to zero, yet it won’t exceed “100” value. In this case, the coefficient of non-ferrous audio signals can cover the range from several hundred up to several thousand points. For example, when this Filter is set for “500”, the Device will receive and emit the identification audio signal related to all the targets with a coefficient which is less or equal to “500”. At the same time, the targets with a coefficient exceeding a value of “500” will be rejected without any identification signal; along with emitting the audio signal with a special “GC” sound or ferrous items (it depends upon a set value of “Sound of GC” in “A” Menu). You should include the Probability Coefficient (PCc) of the targets and phantom signals on the screen into the “V1” Menu, in order to get them displayed.

(!) Targets located deeply in “low signal” grounds, as well as the deeply located targets with “high signal” grounds, the same targets located under the signal stones and signal ceramics, can have the values of Probability Coefficient (PCc) equal to several hundred or even thousand points. It means that they can be cut-off by this filter. Therefore, it’s recommended to use it only if required, trying to finding a balance between the losses of the desired targets and the noise emitted by the Device in complicated hunting environment.

GC Filter (Off 01 ... 20). It's a Filter for signal stones and local changes in ground mineralization.

(!) If in the course of hunting your operation is interfered with a large number of signal stones, local changes in the ground or any other evidence, that make the Metal detector trigger due to the ground heterogeneity, you can apply the GC filter. While making the runs with the coil over such targets, you should increase a value for the Filter until the identification signal would not disappear, or it will not be detected by a special audio signal with a special "GC" beep or "ferrous" items (it depends upon a set value of "Sound of GC" in "A" Menu).

(!) You should remember that this filter can also cut-off the targets located deeply in the grounds. Therefore, it's recommended to switch it on only when there are too many signal stones and signal ground heterogeneity, when their identification and separation from the signals of the desired targets by ear is difficult or impossible.

"A" Menu. Audio Menu. Basic Sound Settings.

To enter, shortly press the button.

Volume (01...10). Adjusts the overall volume for all the Detector's signals.

(!) When using headphones with volume control options, we recommend to decrease the volume in the Metal Detector Menu up to "02-03", and increase it until you adjust the comfortable volume level in your headphones. Excessive volume in the Metal Detector Menu when the operator used the headphones may distort the sound.

GSS Identification (01...20) means the volume of weak signals from the identification channel.

As this set value is increased, quiet signals from the deeply located targets become louder.

(!) You should remember that when the set value is increased, the volume of phantom signals is also increasing. Besides, the overall noise level of your Metal Detector may increase excessively.

It's recommended to use high values of this setting when hunting for deeply located targets or quick navigating upon the areas which contain loose targets.

(!) When hunting upon the areas with high density of debris, keep this set value at the minimum level, in order to avoid excessive overloading with loud signals in case of multiple targets.

Signal Type (to be applied for the Deep Hunting Program/GP only).

1. 1 Tone Signal for all types of targets, the same tone for all the targets.
2. Multi - Tone Signal: low tone for "ferrous" targets, one of 4 high tones for "non-ferrous" targets.
3. 99 Tones: polyphonic sound mode for target identification; low tone for "ferrous" targets, polyphonic multi-tone signal for "non-ferrous" targets.

GSS Detection (01...20) means the volume of weak signals from the detection channel. As this set value is increased, quiet signals from the deeply located targets become louder.

(!) You should remember that when the set value is increased, the volume of phantom signals is also increasing. Besides, the overall noise level of your Metal Detector may increase excessively.

It's recommended to use high values of this setting when hunting for deeply located targets or quick walking navigating upon the areas which contain loose targets.

(!) When hunting upon the areas with high density of debris, keep this set value at the minimum level, in order to avoid excessive overloading with loud signals in case of multiple targets.

VCO Detection (OFF...01...20) means the level of tone modification of the Detection signal, depending upon the modification of the signal value of the target. The higher is the value of this setting, the more sharp is the modification of low tones of weak signals changes towards high tones, when superficial targets have been detected, or when the coil runs from the edge towards the center of the target. Under the value set to "OFF", the detection tone won't be modified, when the signal volume changes.

Duration Fe (00...10) means volume of the identification signal from “ferrous” targets. If the value of the signal from “ferrous” targets is decreasing, the value of the signal from “non-ferrous” targets will remain at the same level. Target identification signal is switched off under the setting level equal to “00”.

(!) It’s recommended to decrease the sound volume from “ferrous” targets, when operation upon the areas which contain a great amount of ferrous debris, in order to reduce the background sound load.

(!) While deep hunting, decreasing volume from “ferrous” targets makes it difficult to identify complicated deeply located signals by ear.

Duration Fe (08...40) means duration of identification audio signal from “ferrous” targets. The lower is the value of this setting, the shorter will be the duration of their signal.

(!) Reducing the duration of the signal from “ferrous” targets significantly increases the sound comfort when working upon the areas which contain huge amount of ferrous debris. Besides, if the ferrous items are not your desired targets, then reducing the duration of the signal from “ferrous” targets will increase the comfort during your standard hunting session.

MIN. Duration of the signals from “ferrous” targets (04...40) means minimum duration of the identification audio signal from “non-ferrous” targets. The more this setting is increased, the longer will be the duration of short signals from deeply located and small “non-ferrous” targets.

(!) Increasing the value of this setting will affect the detection of small and large targets by the length of the identification signal. But at the same time it will help you hear the signals from the complex “non-ferrous” targets located within the debris (along with decreasing values of such parameters as Duration Fe and Loudness Fe) and weak short signals from deeply located targets.

GC Sound (OFF/GC/Fe) means selecting an audio signal intended for the targets (signal stones, local ground changes, etc.) that have been cut- off by the filters in GC and PRc. You can choose one of three options: “GC” (audio signal with a special quiet and short & high tone), “Fe” (audio signal equal to identification signal from “ferrous” targets. The), “OFF” (no identification audio signal).

(!) Sound application of such targets with “GK” audio signal is preferable.

In this case, you will be able to hear them with a quiet “clatter” that does not interfere with the hunting, distinguishing them from other signals; besides, you will be able to check the accuracy of the filters’ operation as well.

Max. Detection Volume (01...10) means separate adjustment of maximum volume of audio signal for Detection channel (it also affects the maximum sound volume in Pinpoint Mode).

(!) This adjustment affects the sound volume of large targets located next to the Metal Detector’s coil, and won’t affect the volume of weak quiet signals. Consequently, by means of its decreasing, you will decrease the sound volume from the large and superficial targets, yet you will never miss weak and deeply located signals.

(!) Excessive decreasing of this setting while standard hunting may cause a faulty evaluation of the deeply located and large targets. You should apply the option of decreasing of Detection Volume while hunting upon the areas which contain huge amount of metal debris.

Source of Identification Tone. Selecting the Source of the Signal Tone for VDI Identification:

HF (high frequency) can be applied when hunting for large targets only

LF (low frequency) can be applied when hunting for small targets, mainly

2F - Average VDI tone of both frequencies (it’s recommended when hunting for a wide range of targets)



Tone Frequency (0200... 0400). Tone of Detection Signal and Threshold Tone.



«A1» Menu. Add-on Video Menu. Tone Settings, Settings for Tone Boundaries

Table of Tones and Borders.

To Enter use long pressing of the button .

Control:

Buttons  and  for switching between tones and boundaries.

Buttons  and  to adjust the selected parameter.
When adjusting the tones, each time you press a button, a beep sounds to match the modified tone.



«AM» Menu. Settings Menu for Discrimination and Identification

To enter use long pressing of the button .

Adjustment of the upper limit of discrimination by 2F ID.

In this window you can set the sector for deviations of the undesired targets in the upper part of the 2F ID Bar from “0” value and up.

(!) For example, when this parameter is set to “05” value, all the targets with a 2F ID value less or equal to “05” will be rejected (the Device won’t emit audio signal for their identification).

All the targets with a 2F ID value over “05” will be sounded with the appropriate tone.

(!) For example, this function can be applied, in order to exclude the identification signals for lumps of coke (overfired coal) with the values of 2F IDs close to “00”, practically without affecting another “non-ferrous” targets.

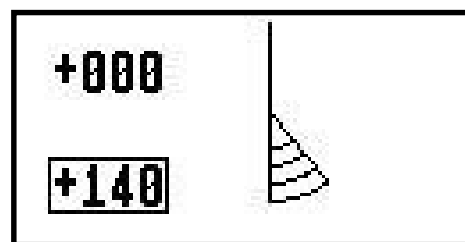

The Lower Discrimination Limit by 2F ID.

In this window you can set the sector of the deviation of the undesired targets at the bottom of the 2F ID Bar, starting from “180” and less.

(!) For example, when this parameter is set to “140”, all the targets with a 2F ID value higher or equal to “140” will be rejected (the Device won’t emit audio signal, in order to identify them).

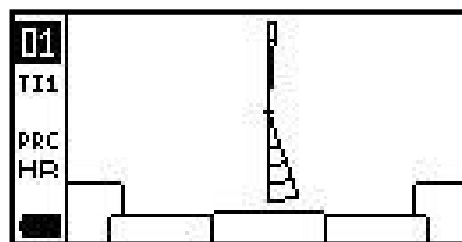

All the targets with a 2F ID value less than “140” will be detected with their matching ID tone.

(!) You can use the discrimination of the extreme upper and lower values of 2F ID, for example, when hunting upon unstable conductive ground, by cutting-off its phantom signals in the sectors 2F ID within the range “0... 5” and “175 ... 180”. However, we you should remember that it’s possible to skip small low conductive targets with 2F ID of the discriminated sector, as well as deeply located targets.

Enabling and Disabling of Discrimination Mode in 2F ID in Hunting Mode

This procedure is performed by short pressing of the button



In this case, the shaded sectors of the discriminated targets will appear on the hunting display.

Discrimination Mode has been enabled.

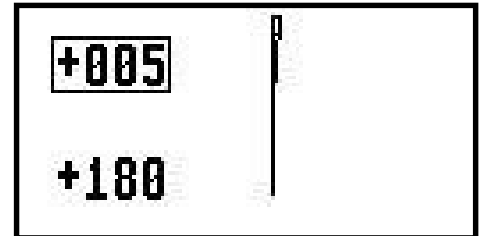

Sector no Fe (00...90) allows you to detect the target with a an audio color signal within the boundaries of the sector set at 2F ID from “000” value and up, regardless of their physical nature and true identification by the Metal Detector.

(!) For example, if you set the border of this sector to “30”, then all the targets with 2F ID less or equal to “30” will be detected with color sound tone, notwithstanding the fact that even if by all their physical properties they are “ferrous” items as identified by the Metal Detector. Consequently, the lower is 2F ID value, the less is the probability that it’s a “ferrous” target; this approach can be helpful when hunting for small and low-conductive targets located both among signal stones and in highly mineralized grounds. This approach is specifically applicable in operations with the coils with low-frequency working pairs (for example, for the sensors from “214” series in the 2F ID within the range “0...30”, where there are practically no desired “ferrous” targets, while there can be a great number of the desired targets made of low-conductive alloys).

Filter limit TI1 (00... -60) means the border of the sector with “undistinguished ferrous items” related to the single-frequency VDI targets. Ehen operating in this sector, the Metal Detector, using multi-frequency processing, will detect “ferrous” targets from “non-ferrous ones (normally, they are low-conductive and superficial targets), which have been distinguished by the ground signal into the “ferrous” VDIs items. Maximum value of the Fe Border is “-60”. This setting is applied in complex with the TI1 filter setting.

TI1 filter (100 ... 500) means TI1 (Target Index 1) level above which the Metal Detector will identify the target as “non-ferrous” one, despite the positioning of hodographs and VDI at both frequencies at the location of “ferrous” items.

(!) “Ferrous” items located within the boundary limits of Fe (0... -50) can hardly ever possess the Ti1 value that would be higher than “250”, normally, the range is “100-150”. However, “non-ferrous” small and low-conductive items that can be detected by the signal into this area, normally possess a Ti1 value higher than “350”. If you set a TG_i value of Fe Boundary equal to “400”, you will surely to accurately detect “non-ferrous” items by the ground signal within the area of “undistinguished ferrous items”.

By decreasing a TI1 filter value, you will be able to detect even more “non-ferrous” targets, which have been classified by the ground signal, however, the lower is this value, the more likely you are to detect the undesired “ferrous” items by the of the “non-ferrous” items.

(!) For example: a small target has VDI +07 +35 as an “air” value and hodographs for “non-ferrous” metals. At the same time, in mineralized ground, its single-frequency VDIs can be changed, being detected by the ground signal, and become -80 -37, while the hodographs will also be classified within “ferrous” area, where there are many “ferrous” items that possess the same VDI.

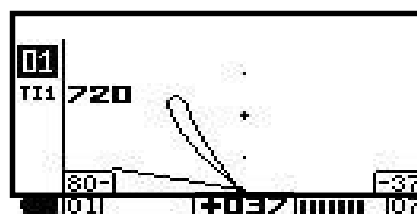
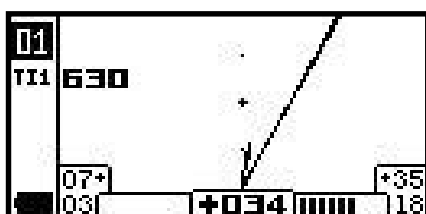

Any single frequency metal detector would determine this target as a “ferrous” one, and you would accept it. Device “Intronik STF”, by analyzing the target signal at different frequencies, is capable to detect the fact of mismatching, due to the calculated Target Index (Ti1) as per a single frequency VDI target; so, it would determine this target as a “non-ferrous” one. The procedure is as follow: the TI1 filter border should be set to a value of -40 at least (so that the high-frequency VDI -38 would falls into the “undistinguished ferrous items” area), and the TI1 filter should not exceed “400” value (for such low-conductive targets, Ti1 is usually higher than “400” (in this case, the values is “630/720”), while “ferrous” items with such VDI possess less than “250”).

Filter Sensitivity TI1 (01... 02) means that this setting is matching the sensitivity of the TI1 Filter for the targets. Under a value of “01”, the filter will process only sufficiently significant signals with a low frequency “01” rating. Under a value of “02” for this setting, the filter will process even the weakest signals for the entire set sensitivity range of the Metal Detector. It will be helpful for detecting more deeply located and small “non-ferrous” targets, which were classified by the signal into the “ferrous” area”, though it can also cause a slight increase in filter errors awhile detecting some “ferrous” items.

Discrimination Detection (ON/Off) means discrimination of the detection signal. This setting will help you enable or disable the Detection signal for those targets which have been rejected as per 2F ID or filters in discrimination areas.

(!) Switching off the Detection signal for the targets which have been rejected by the Metal Detector reduces the overall acoustic loading. However, at the same time it can change the regular audio “picture” of the ratio between the Detection and Identification signals and the accepted targets.

Discrimination of Fe Caps (OFF...01...05) means discrimination of ferrous beer caps. As far as this function is enabled, your Metal Detector will replace the standard “non-ferrous” signal of ID channel with a “ferrous” signal for such purposes. The higher is the level of this setting; the lower is the option for the iron beer caps to be detected by the “non-ferrous” signal. However, there is a small probability of scoring with an iron tone of complex and deeply located “non-ferrous” targets, because it is almost impossible under the low set values. Application of the Function of Discrimination of Fe Caps is recommended when hunting at the beaches and in public areas.

(!) This function can also be used, in order to cut-off small rusty pieces of roofing iron, as well as any other small flat iron pieces.

Identification Acceleration. As soon as this function has been enabled, the Metal Detector would spend less time of the target’s identifying, it will accelerate its operation. However, at the same time, a certain number of epy identification errors of “ferrous” items by a “non-ferrous” signal might happen.

«V» Menu. Video Menu. Display Settings, Settings for Data Display

Short pressing of the button .

Scale D of the Hodograph (1...5). It increases the Hodograph’s size D on the Display of the Metal Detector.

(!) When hunting for very weak signals from deeply located targets, their D Hodograph may turn to be too small and hardly visible. In order to increase it, update the increased Gain value of the D Hodograph’s setting. It can be useful when completing the hunting procedure for the targets with their known properties.

(!) On the contrary, when working in the areas with a large number of surface and superficial metal items (i.e. metal debris), too much increased values of D hodograph will not match the display size, so, instead of the useful information you will see chaotic messed lines only. You should reduce the Gain value of the D Hodograph’s setting as much as possible, and then you can see its direction and shape.

Contrast (01...15) is designed to adjust the level of the picture contrast on display.

(!) In bright sunlight, the increasing value of the “Contrast” setting may improve the visualization of display data on the screen of the Metal Detector.

Backlight brightness (OFF, 1, 3). This option switches on and adjusts the level of backlight brightness of the display.

(!) In dark environment, increasing the backlight brightness will help improve the visualization of display data on the screen of the Metal Detector. At the same time, when hunting in dark environment, provided that you've forgotten to pick your headlamp, decreasing backlight brightness will help reduce the screen flashing.

Language. Selection option for Language Menu of the Device.

«V1» Menu. Add-on Video Menu. Control of Data Display

Long pressing of the button.

Hodograph D (ON/OFF). Switches ON and OFF the picture of D Hodograph on display of the Metal Detector.

HF Hodograph (ON/OFF). Switches ON and OFF the picture of SFT high frequency Hodograph on display of the Metal Detector.

LF Hodograph (ON/OFF). Switches ON and OFF the picture of SFT low frequency Hodograph on display of the Metal Detector.

TI1 Display (ON/OFF). Switches ON and OFF the picture of TI1, a dual frequency Target Index on display of the Metal Detector.

TI2 Display (ON/OFF). Switches ON and OFF the picture of TI2, an optional dual frequency Target index 2, on display of the Metal Detector.

PRc Display (ON/OFF). Switches ON and OFF the picture of PRc (Probability Coefficient), on display of the Metal Detector.

Extended Explanation for Display Target Information

Hodographs of the separate frequencies.

1. SFT High Frequency Hodograph (HF)
2. SFT Low Frequency Hodograph (LF)

Hodographs are displayed after the target has been identified; they remain displayed until the next target has been identified.

What is Hodograph?

Signal emitted by the detector (coil) of a Metal Detector is a vector value; it is characterized by its related amplitude and phase. If you bring any metal item to the sensor, it is obvious that the magnitude of this vector would change. In this case, the ending point of the vector would trace some figures (rays, loops, etc.) at the coordinate plane. Such figures are called hodographs. Hodographs describe the complex nature of the sensor's interaction with metal targets in the most complex manner, in comparison to VDI. When analyzing hodographs, you should consider a few general rules:

- hodographs of small and medium ferromagnetic (ferrous) items are located in the left half of display and correspond to the negative VDI values
- hodographs of the items made of non-ferrous metals, as well as large ferromagnetic items are located in the right half of display and correspond to the positive VDI values

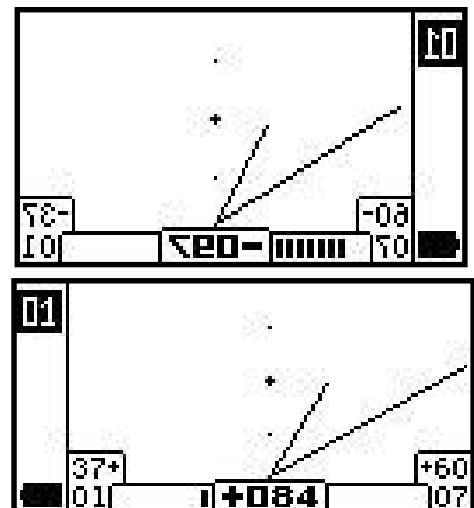

- the larger is the area of the item's reflecting surface and the higher is its electrical conductivity, the greater is the hodograph's incline to the right

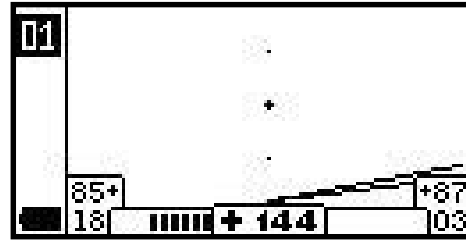
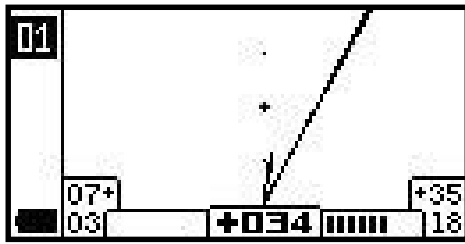

Small non-ferrous target

Large non-ferrous target.

- Hodographs of large ferromagnetic (ferrous) items, normally, look like a wide loop. And can sometimes give a color identification signal.

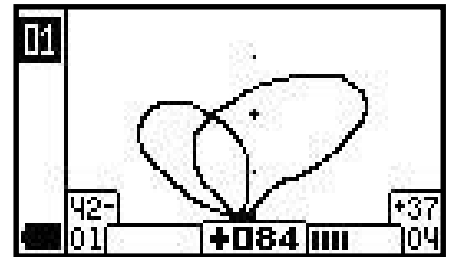

- Hodographs of the items made of non-ferrous metals, normally, look like straight lines or narrow loops

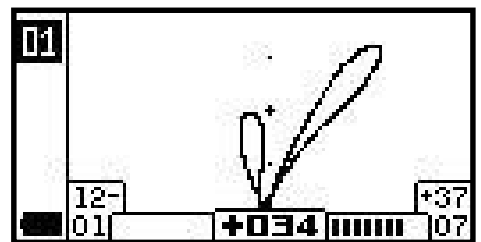
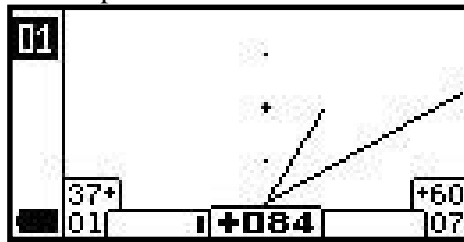

- strong incline of the target hodograph to the left is a sign of its ferromagnetic nature even if it has been detected by a “non-ferrous” audio signal from the identification channel. Image also displays the “cross” symbol located in the upper left corner of display. This symbol located on display of the Metal Detector “Intronik STF” means that high and low frequency hodographs switched their locations (a low hodograph has taken a position under a high hodograph). When the signal is strong, it also means a “ferrous” target detected

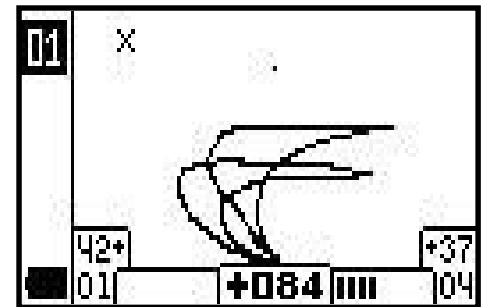

Simultaneous Analysis of Two Hodographs of Target Signal at High and Low Frequencies

Being a simultaneous dual-frequency Metal Detector, Device “Intronik STF” displays information related to the targets simultaneously at two frequencies of the working pair: at Low Frequency (LF) and at High Frequency (HF). Analyzing two hodographs of a target can provide a lot of additional information about its nature. For example, the thinner is a target made of the same alloy, the faster its signal will become weaker for low frequencies; however it will remain strong enough at high frequencies.

(!) Ratio of hodographs' length means the ratio of signal volume at low and high frequencies. That is, the longer is the hodograph, the stronger is the signal. On the contrary, the shorter is the hodograph, the weaker is the target signal at that frequency.

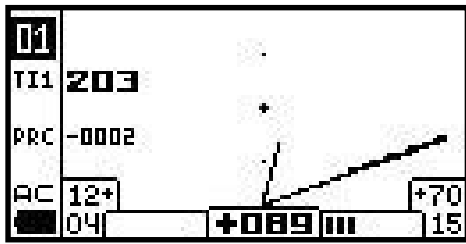

Thin copper plate

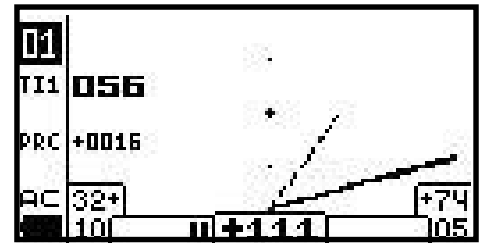

Small copper coin

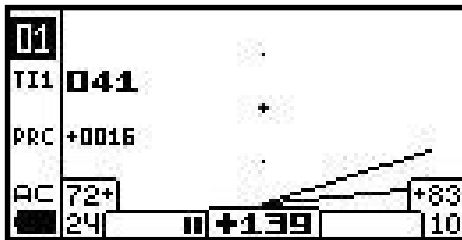

Middle-sized copper coin with thickness of 1-2 mm

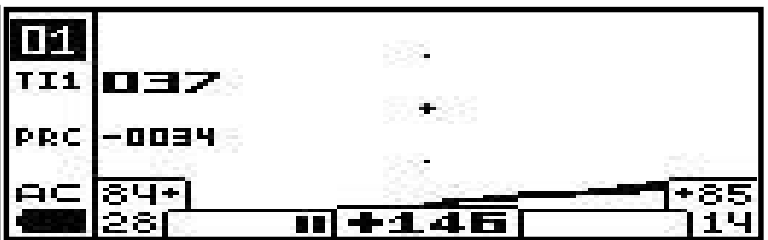

Big thick copper coin

In the same way, for low- and medium conducting “non-ferrous” targets (VDI range is “0...+60” in HF) the signal strength at low frequency (LF) cannot be equal, or even stronger its value at high (HF) frequency. Its value is always lower. Therefore, the hodograph of low frequency in a combination of hodographs for signals of such “non-ferrous” targets is always shorter (Fig. 10, Fig.11, Fig.12)

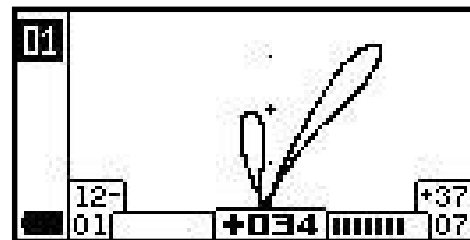
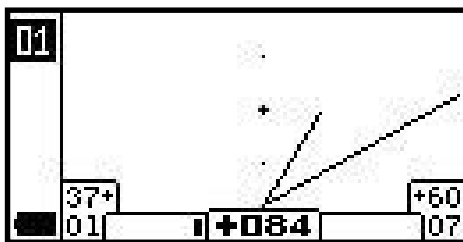
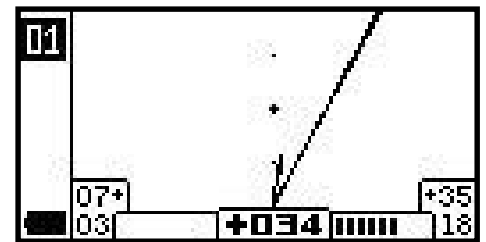

At the same time, iron rings, sheets of roofing iron, which also have a close VDI in high (HF) frequency (within the range “0..+50”), possess a very strong signal in low (LF) frequency. Combination of hodographs for such a signal can have a different picture, making it clear that this is a “ferrous” target, notwithstanding a “non-ferrous” signal, because there is no option for such a ratio of the lengths of hodographs at high and low frequencies is not for non-ferrous targets in this VDI range.

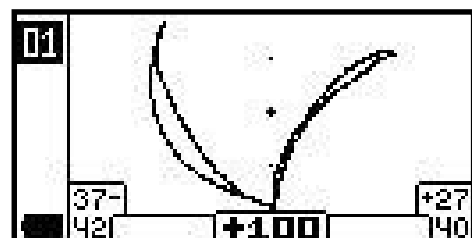

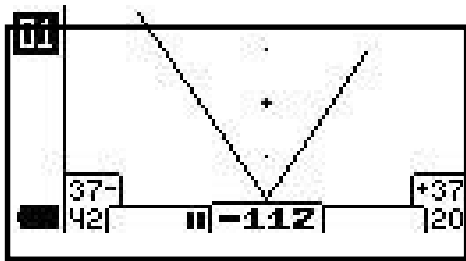

D Hodograph (2F) is displayed in real time as the coil passes over the target, its picture disappears from display after the target leaves the coil cover area or the coil has stopped.

Inclination angle of D Hodograph from the vertical axis corresponds to the main dual-frequency target identification number - 2F ID. It can be equal for both ferrous and non-ferrous targets. Such signs as “plus” or “minus”, as well as the matching tone, are registered by the 2F ID identification algorithm of the Device.

D Hodograph for “non-ferrous” targets and ferrous rod targets has usually linear shape.

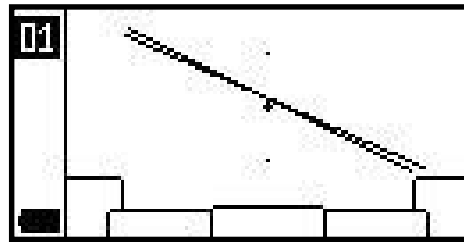
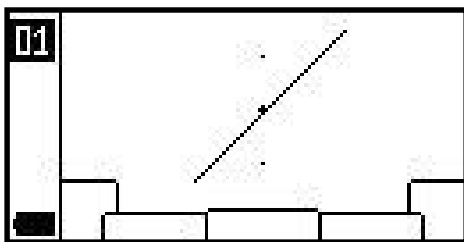

D Hodograph for large and flat ferrous targets is “8”-shaped

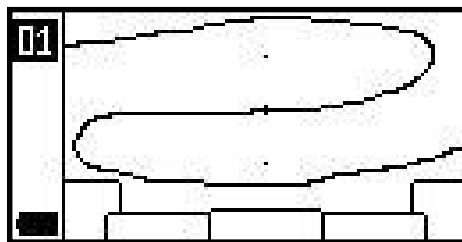
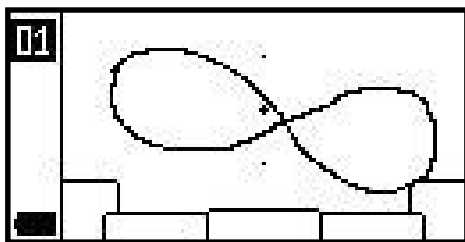

D Hodograph for a decayed and crumbling iron piece may have the following shape:

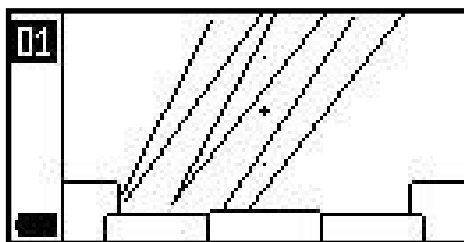

Digital Data about the Target.

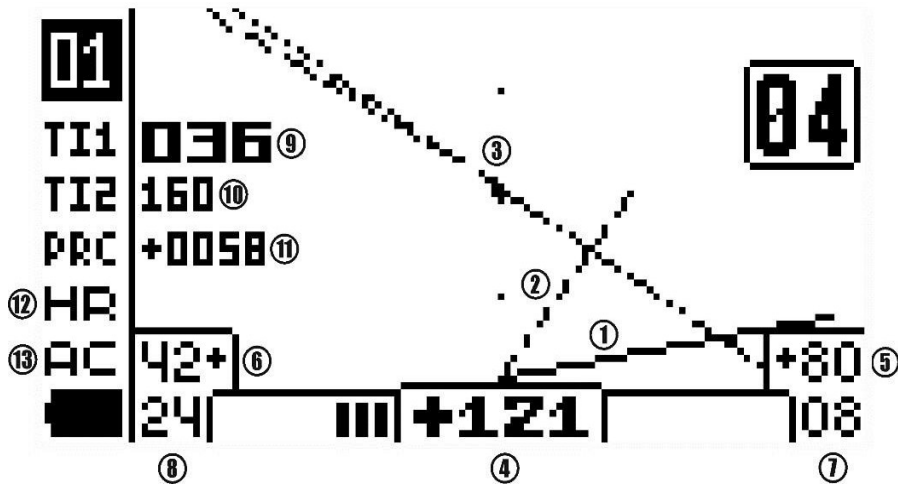

1. 2F ID (000...180) is a Dual-frequency ID (identification number) of the target. It corresponds to the angle of deviation D of the hodograph of the target signal from the vertical axis. Depending on the identification of the target by the Metal Detector, it can possess either a “minus” (ferrous targets) or a “plus” (non-ferrous targets) value. In contrast to single-frequency VDI, it is much less affected by the modifications due to the influence of the ground signal. Ferrous and non-ferrous targets can have the same 2F ID, such signs as a “plus” or a “minus”, are registered by the 2F ID identification algorithm of the Device.

2F ID has a graduation scale of 180 points, where low-conductive targets are at the beginning of the scale, while large high-conductive targets are near the end of the scale.

For example:

Salty water – 000
 Foil - + 001 .. + 005
 Medieval silver coin - + 030..+ 060
 Middle-sized bronze coin - +090
 Middle-sized silver coin - +110
 Large copper coin - + 130.. + 145

The 2F ID option for the same target will differ for the different frequency pairs. As a general rule, on a higher frequency pair, all targets increase their 2 F ID value. Moreover, it is not linear; it is strong for small low-conductive targets, while it has less potential for large high-conduction targets and iron.

For example:

Frequency pair 2/14
 Small Medieval Silver Coin - +034
 Middle-sized Bronze Coin - +086
 Middle-sized Copper Coin - +142
 Small iron nail - -88

Frequency pair 5/40 (for the same purpose)

Small Medieval Silver Coin - +061
 Middle-sized Bronze Coin - +114
 Large Copper Coin - +140
 Small iron nail - -105

5. VDI (HF) (-99 ... 0 ... + 99) means a single frequency VDI target at high frequency.
6. VDI (LF) (-99 ... 0 ... + 99) means a single frequency VDI target at low frequency.

Commonly accepted single frequency for VDI targets.

The more conductive and larger the target is, the more VDI it possesses.

Approximate range:

-99... -85 Very small ferrous targets, rust, hot stones, ground phantoms.

-85 ... -60 Fine iron.

-60... -40 Forged nails.

-40... -10 Massive iron items. (There can be small targets demolished by the ground signal)

00 Thin foil.

00... + 10 Thin chains, slices of foil, small low-conductive targets.

+ 20... + 40 Small silver coins.

+ 40... + 60 Small copper coins, middle-sized silver coins.

+ 60... + 80 Large silver coins, middle-sized copper coins.

+ 80... + 85 Large copper coins.

+ 85... + 99 Very deeply located targets, “superficial”, cold stones, ground phantoms.

VDI on a high frequency target is usually always higher than at low frequency.

7. Signal rating (HF) (00 ... 99) means a target’s signal volume at high frequency.

8. Signal Rating (LF) (00 ... 99) means a target’s signal volume at low frequency.

‘s signal strength intended for a Metal Detector. Targets located at the sensitivity limit have a rating close to 00. Targets located on the surface or large superficial targets have a rating close to “99”.

Frequency rating depends on the magnitude and conductivity of the targets. For non-ferrous low and medium conductive targets, the high frequency rating is always higher than at low frequency.

On the contrary, for “ferrous” items the low frequency rating is higher or equal to the high frequency rating.

9. Ti1 (Target index) (000...999) means a Dual Frequency Target index. It provides the information about the overall magnitude and conductivity of the target. The smaller the target is and the lower its conductivity is, the higher its TGi value is.

On the contrary the larger the target is and the more conductive the metal that composes it is, the lower its Ti1 value is.

For example:

Thin gold chain - Ti1 = 750

Small cross - Ti1 = 450

Small coin - Ti1 = 350-270

Forged nail - Ti1 = 110

Large copper coin - Ti1 = 036

This concepts served as a basis for a filter for detecting the rejected small “non-ferrous items” which have been classified into this sector of “undistinguished ferrous items” (See Ti1 Filter in the “AM” Menu. Discrimination Menu).

(!) Ti1 value of the same targets when using coils with different frequency pairs may be slightly different.

10. Ti2 (Target index 2) (000 ... 999) means Additional Dual frequency Target index. When compared with the basic Ti1, with experience it can provide the specified information about the nature of the target.

(!) Related to ferrous” targets, Ti1 and TGi2 values generally have the same meaning. Their obvious difference can sometimes indicate the “non-ferrous” nature of the target.

Try some experiments, remind the items while digging, gain the experience to operate with such differences.

11. PRC (Probability Coefficient) (0000..9999) means “Probability Coefficient” of the target. It helps in distinguishing the signals of evident metallic targets from the signals of a probable “non – ferrous” nature, if required. Generally, evident signals from metal targets possess a PRc value that never exceeds “100”. At the same time, signals emitted due to the hits with a coil, electrical noise, false signals from the ground, signals from stones, not always, but it can have PRc from several hundred to several thousand. Having estimated the PRc value of such interfering signals on the metal detector screen, you can use the PRC filter (see “M1” Filter Menu), in order to exclude the scoring of such signals by the Device.

(!) However, at the same time you should remember that the weaker the target signal is and the stronger the ground signal is, the higher the probability is that the PRC of metal targets can greatly increase, and these targets can be blocked by a low PRC filter value.

Useful Links

1. Electronic version of the instruction on the website <https://aka.2000.ru/support.htm>
2. Topic on the Intronik STF metal detector on the “Reviewdetektor Forum”, where you can ask questions and get answers with the advice how to master. Besides, the first news to be posted is the useful information, it is constantly updated; links to new firmware upgrade, updating instructions and new training videos. <https://www.reviewdetector.ru/index.php?showtopic=2407425>
3. YouTube video channel, where you can find training and information videos related to “Intronik STF” Device https://www.youtube.com/channel/UC0ChquTf9D8W3DwcT2k3V_g

Terms of Warranty

1. Warranty repair of the equipment is performed upon presentation of a fully completed Warranty Certificate by the Customer.
2. Delivery of the equipment subject to warranty repair to the service department performed by the Customer independently and at his own expense, unless otherwise additionally agreed.
3. Warranty Obligations do not refer to the materials and parts that are considered consumable during the operation.

Terms of Interruption of Warranty Obligations

Warranty Obligations may be interrupted in the following cases:

1. Inconsistency of the serial number provided for the equipment warranty service with the serial number indicated in the Warranty Certificate and/or other written agreements.
2. Presence of obvious or hidden mechanical damage to the equipment caused due the violation of the rules of transportation, storage or operation.
3. Non-compliance with the Rules and Operating Conditions for equipment of this type revealed during the repair procedure.
4. Damage to control labels and seals (if any).
5. Presence of foreign objects inside the housing of the equipment, regardless of their nature, if such an option has not been specified in the Technical Documentation and Operating Manuals.
6. Equipment failure caused by force majeure factors and/or actions of the third parties.

Warranty Certificate

Manufacturer guarantees the operation of the Metal Detector, provided that the consumer observes the operating conditions.

Duration of the warranty period is 36 months for the electronic unit and 12 months for the sensor (coil), starting from the Sale Date.

During the warranty period, a manufacturing defect shall be eliminated by the Manufacturer free of charge, in the absence of conditions for interrupting the warranty.

In order to fulfill the warranty repairs, you should present a filled-in Warranty Certificate.

In the absence of a note of sale, the Warranty period shall be calculated, starting from the Production Date.

Claim Address:

Production and Sales Data

Metal Detector “INTRONIK STF”, No. _____

Frequency pair / kHz sensor No. _____

Production Date “____” 20____

Manufacturer’s Seal

Suitable for use Signature of the responsible person.

Sale Date “____” 20____